



MEDISCA[®]
YOUR TRUSTED PARTNER IN COMPOUNDING

PRODUCT NO.: 7379













MD™ Syringe (5mL, 0.15mL Metered Dose)

Pump with Bottle & Cap, White with Clear View Window

DESCRIPTION: The new portfolio of MD Dispensers was engineered for accuracy with a professional structure, yet designed to convey a cosmetic appeal. The MD Dispenser will maintain the integrity of a formulation, allowing users to dose preparations easily and accurately. The first of its kind on the market, this dispenser features a UV resistant view window for added convenience.

FEATURES:

-  Airless dispensing
-  Sleek professional look
-  Silicone tip for smooth application
-  Metered dispensed volume
-  Excellent evacuation
-  Minimal priming required
-  UV-resistant
-  Protection from oxidation
-  Hygienic use, no bacterial contamination
-  Latex-, BPA- and PVC-free

TECHNICAL SPECIFICATIONS:

Capacity (mL)	5
Dispensed Volume (mL)	0.15
Precision (% RSD)*	< 2.0
Material of Construction	Inner Bottle: Polypropylene Outer Bottle: PETG Cap: PETG Collar: Silicone
Dimensions, L × Ø (cm / in)	10.8 x 2.0 / 4.2 x 0.8

Color	White with view window
Filling Method	3 piece assembly: 1. Top-Filled Syringe 2. Snap-Cap Spring Pump 3. Outer Casing
UV-Resistance	Bottle: Yes View Window: Yes

* Value established using Medisca cream bases.

FILLING INSTRUCTIONS:

MD Syringe

TO FILL :

TO USE :

To minimize air entrapment and ensure proper function:

- Use a nozzle to fill from the bottom up.
- Tap the dispenser multiple times while filling to flatten the cream and evacuate air.

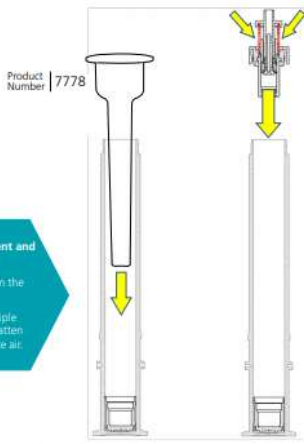

1. Fill cartridge

2. Snap actuator onto cartridge by only pressing on the outer collar. Avoid compressing the spring. Ensure there is no gap between the actuator and the cartridge

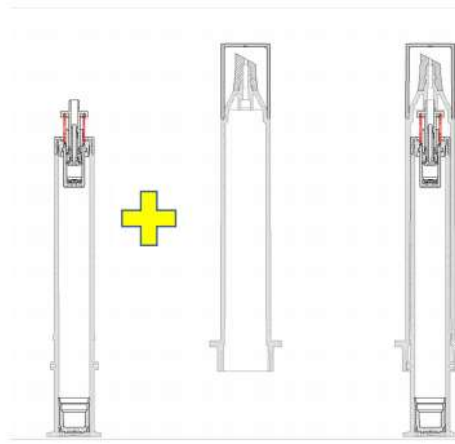

3. Align tabs and insert cartridge into housing

4. Make sure the cartridge is twisted to the lock position - the syringe is ready for use

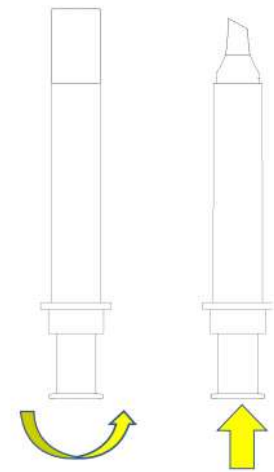

5. Twist to unlock

6. Press to dispense (may require a few pumps to prime)